

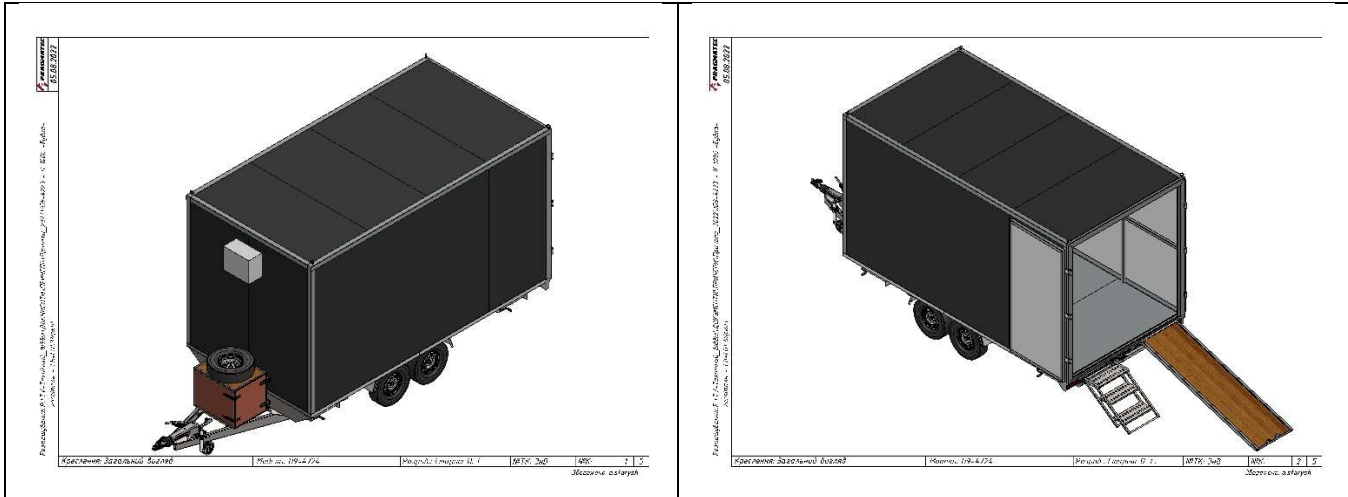







Service Ukraine
Kulpakivska str.
Lviv, Ukraine



Specialized medical trailer		
Type	Description	Price \$
Trailer	Net 2310 kg/Max 3510 kg	
Frame	Reinforced galvanized metal frame with stabilator	
Brakes	4 wheels braking system for driving and stand still	
Spare wheel	1 extra standard wheel with tire	
Box material	50 mm thermal insolated sandwich metal construction	
Doors	2 back doors open separately with key lock	
Ramp	Metal frame with slip resistant aluminum surface	
Stairs	Metal frame with slip resistant metal stairs	
Anker stabilization	4 lower units, 4 top units with wire hook system	
Shelves	12 secured medical box system for supply with transparent storage boxes	
Shelves	5 secured shelves for heavy medical equipment	
Shelves	1 shelf for light medical equipment	
Storage	Clothing wardrobe, anker equipment, cables	
Toilet room	4 secured box system, Bio-toilet Thetford Campa Potti Qube XGL	
Washstand	400mmx400 mm stainless steel with water tap	
Water cleaning	Reversed Osmos, Aquaphor OSMO Pro 50 reverse osmosis system	
Water pump	TBA	
Table	Folding table 600 mm x 400 mm	
Lamps	7 LED top light 6400 lumina	
Plug-out	External 380V with 20 meters cable	
Generator	7,5 kW diesel generator, Konner sonnen KS 8102HDE-1/3 ATSR 380v/220v	
Fuse for electric	Separate system for equipment, lighting, conditioner.	
Ground connection	Lighting system with ground connection	
Heating/cooling	Conditioner with thermostat TAC-09CHSD/XA31	
Locks	Safety lock system for all equipment under transportation on harsh surface	
Fire system	1 x 8 kg fire distinguisher	







Service Ukraine
 Kulpakivska str.
 Lviv, Ukraine

Medical equipment		
Type	Description	Price \$
Surgery table with gynecology option.		
Round seated doctors with wheels		
Patient chair		
Surgical kit (Half set for emergency use)		
Gynecological kit. Disposal kits x 20		
Portable Defibrillator (MindRay BeneHeart C1A automatic)		
Cardiograph (Heaco G3D mode switch adult/children)		
Stethoscope (Multi-functional SPRAGUE RAPPAPORT)		
Electrocoagulator (EHVA 350M/128B - model 50PX)		

Service Ukraine
Kulpakivska str.
Lviv, Ukraine

Portable lung ventilator (HEACO OLV 5 liter)		
Autoclave for 20 l (Zapovit GP20)		
Panmed for 2 wings (PANMED -M5)		
Otoscope set (Reister 2050)		
Portable ULTRASOUND (based on tablet)		
Bactericidal irrigator-recirculator (ORBE 5-30 - 200 m3/h)		
Tonometer (LUX MicroLife BP-2A Classic)		
Pulse oximeters x 5 (JZK-230 one finger Oximeter)		
Reanimation kit		
Refrigerator (blood cooler)		

Service Ukraine
 Kulpakivska str.
 Lviv, Ukraine

Walkie-talkie x 3 (Up to 5 km range)		
Storage boxes for medical supply x 17		
Blood and bottle holder		
Laptop Lenovo (V14 G2 ITK, 14" screen)		
Wi-Fi-router ZyXEL LTE3301-PLUS (LTE3301-PLUS-EU01V1F)		
4G LTE MIMO-antenne RNet 1700-2700 MHz 15 D		
GPS tracker (Battery 10000 mAh in 180 days)		
Installation of medical electric equipment and testing Installation of IT system Installation of various other equipment Training plan to setup the unit Transportation Certificate to get number plates registration Service documentation		
Price	Mobile unit, medical equipment, and installation. Including VAT	37.500